

## HYDROCAL 1003

Transformer Online Monitoring System with Gas-in-Oil and Moisture in Oil Measurement



Analysis of the gases dissolved in power transformer oil is recognized as the most useful tool for early detection and diagnosis of incipient faults in transformers.

In addition, water contamination deteriorates the performance of the oil as high moisture content increases the risk of corrosion and overheating. This is in particular when the water content reaches the saturation point of the oil and free water is formed.

Besides regular gas chromatographic analysis and off-line moisture analysis of the isolation oil of power transformers online monitoring systems gain more and more importance worldwide.

By online monitoring of the key fault gases Hydrogen ( $H_2$ ) and Carbon Monoxide (CO) and Moisture in Oil ( $H_2O$ ) an additional potential of cost reductions and safety improvements can be achieved.

### Key Advantages

- Individual analysis of the dissolved gas contents for Hydrogen ( $H_2$ ) and Carbon Monoxide (CO)
- Analysis of moisture ( $H_2O$ ) dissolved in transformer oil (both, relative humidity [%] and absolute humidity [ppm])
- Easy to mount on a transformer valve (G 1 1/2" DIN ISO 228-1 or 1/2" NPT ANSI B 1.20.1)
- Installation on the operational transformer without any operational interruption
- Advanced software (on the unit and via PC)
- Maintenance free system
- Communication interfaces ETHERNET (Option) 10/100 Mbit/s (copper-wired / RJ45 or fiber-optical / SC duplex), RS 232 and RS 485 to support MODBUS<sup>®</sup>RTU/ASCII, DNP3 proprietary communication and IEC 61850 protocols
- Optional DNP3 software Stack modem / RS 485 Anschluss (DNP3 Protokoll)  
Optional IEC 61850 software stack modem for modem for SCADA connection over IEC 61850 protocol

## Transformer monitoring functions

### Voltages and Currents

(via voltage and current transformers / transducer)

### Temperature Monitoring

Bottom and top oil temperature, ambient temperature  
(via additional temperature sensors)

### Cooling Stage / Tap Changer Position

(e.g. via current transducer)

### Free configuration

Analog inputs can be free allocated to any additional sensor

### Further Calculations:

Hot-Spot  
Loss-of-Life  
Ageing Rate } joint development  
with PAUWELS  
Belgium

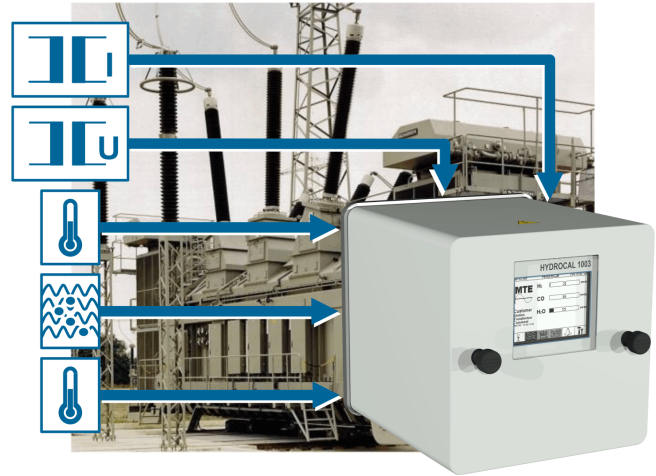

## Communication

### RS 232 (Standard)

- RS 232 interface (connection on back plate - without removing protection cover)
- On-site, e.g. with notebook via proprietary protocol

### RS 485 (Standard)

- Bus-Operation or point-to-point operation
- MODBUS® RTU/ASCII or proprietary protocol
- Bus length up to 1000 m
- Communication with up to 31 HYDROCAL units
- Configuration via internal firmware or PC software HYDROSOFT

### Analog modem (Option)

- Integrated on-board analog modem with connection cable 15 m
- Proprietary protocol

### Ethernet modem (Option)

- Internal ETHERNET 10/100 Mbit/s communication modem (copper-wired / RJ45 or fibre-optical / SC duplex)
- IEC 61850 (prepared) or proprietary protocol

### DNP3 modem (Option)

- Internal DNP3 serial modem with RS 485 interface
- DNP3 protocol

## Unit mounting

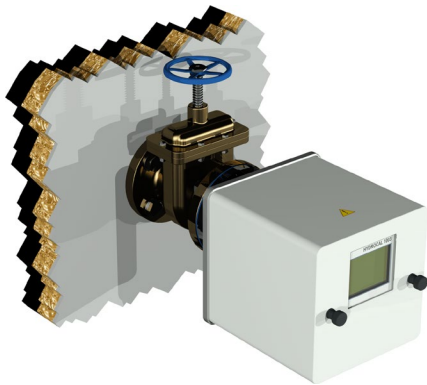

### Transformer without cooling system

Mounting of the HYDROCAL 1003 unit on a valve on the transformer tank.

Natural oil convection inside of the transformer is ensuring the exchange of the oil at the membrane.

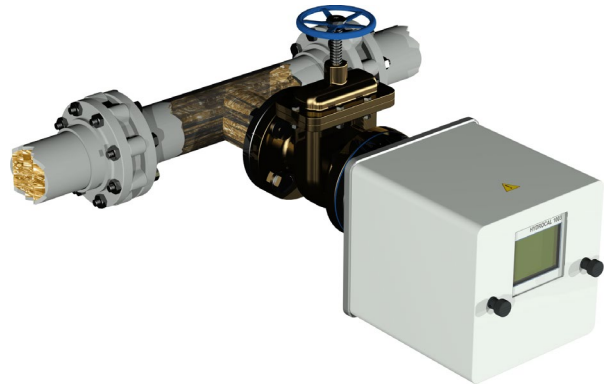

### Transformer with cooling system and forced oil flow

The HYDROCAL 1003 unit is mounted on a T-fitting valve on the return flow of the cooling system.

The forced oil convection is ensuring the exchange of the oil at the membrane.

# HYDROCAL firmware main menu

## 1 Customer data

- Customer
- Station
- Transformer
- Comment

## 2 Gas-in-oil overview

- Column chart
- Trend graph
- Data table

## 3 Transformer specific measurements

- Trend graph
- Data table

(to be included)

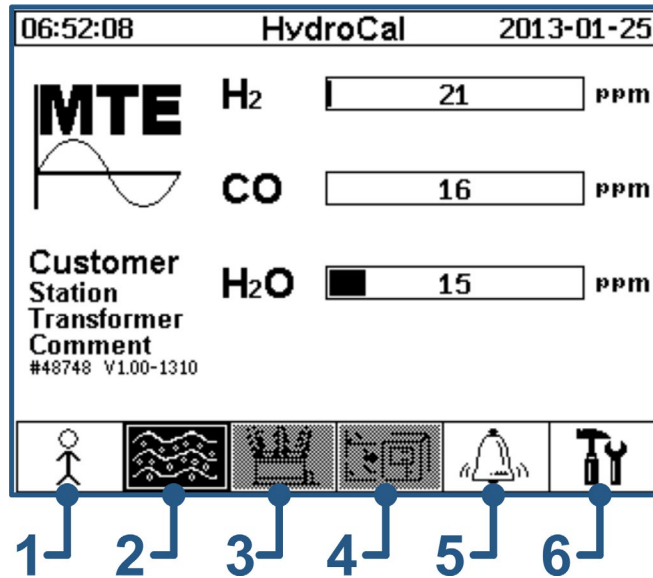

## 4 Additional sensor measurements

- Trend graph
- Data table

(to be included)

## 5 Alert overview

- Alert acknowledgement
- Alert table

## 6 Device setup

- Alert level setting
- Communication setting
- Transformer setting
- In- and output setting

### Gas-in-oil trend

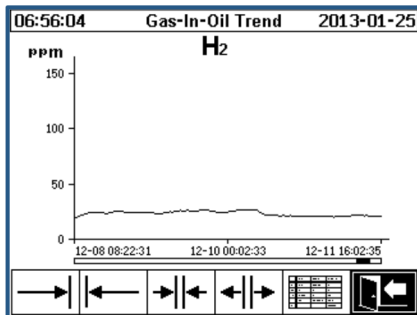

A graph displaying the trend over the time, in this case Hydrogen (H<sub>2</sub>), is shown.

### Gas-in-oil overview

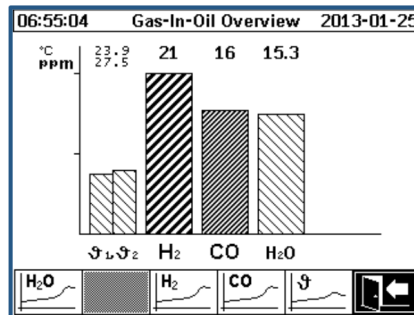

Individual chart diagram for Hydrogen (H<sub>2</sub>), Carbon Monoxide (CO), Moisture in Oil (H<sub>2</sub>O) and temperatures.

### Alert overview

#	Name	Date/Time	Status
1	H2-Alert	07-30 11:09	✓
2	CO-Alert	07-30 11:10	✓
3	H2O-Alert	07-30 11:10	✓

Display of alarm list. Details of each alarm and individual settings is shown.

## HydroSoft PC-Software

### Program key features

- Configuration and administration of each individual HYDROCAL unit
- Data and configuration read out of HYDROCAL units
- Processing and presentation of data read out (Trend or table)
- Further processing of the processed data (Excel, CSV, clipboard and printing)
- Storage of the processed data and unit configuration
- Automatic data read out and alerting by e-mail

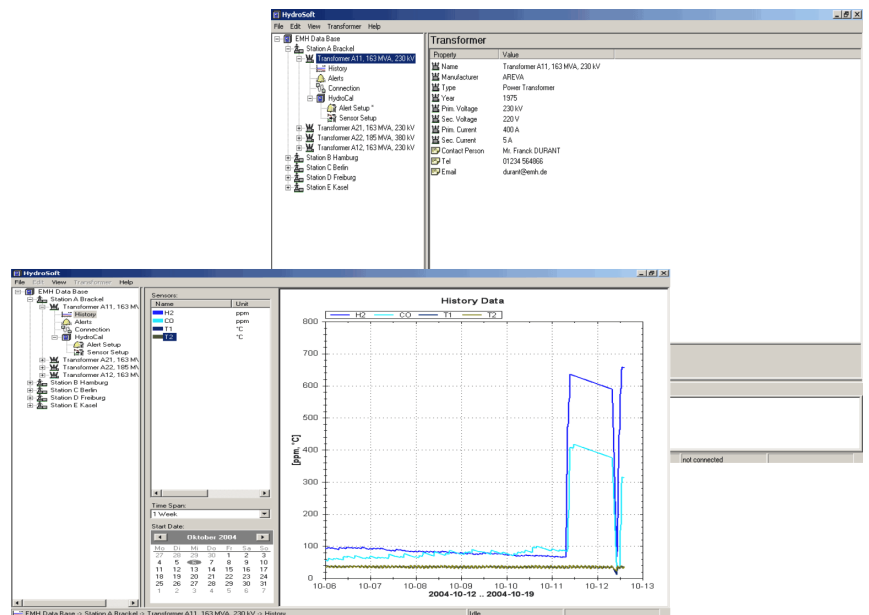

# Technical data HYDROCAL 1003

## General

Optional nominal voltages of auxiliary supply: 120 V -20% +15% AC 50/60 Hz <sup>1)</sup> or 230 V -20% +15% AC 50/60 Hz <sup>1)</sup> or 120 V -20% +15% DC <sup>1)</sup> or 230 V -20% +15% DC <sup>1)</sup>  
Other nominal voltages on request!

Power consumption: max. 200 VA

Housing: Aluminium

Dimensions: W 224 x H 224 x D 307.5 mm

Weight: Approx. 7.5 kg

Operation temperature: (ambient) -50°C ... +55°C (below -10°C display function locked)

Oil temperature: (inside transformer) -20°C ... +90°C

Storage temperature: (ambient) -20°C ... +65°C

Oil Pressure: up to 800 kpa (no negative pressure allowed)

Connection to valve: G 1½" DIN ISO 228-1 or 1½" NPT ANSI B 1.20.1

## Safety

Insulation protection: IEC 61010-1

Degree of protection: IP-55

## Measurements

Gas/Moisture in oil measurement		Accuracy <sup>2) 3)</sup>
Measuring quantity	Range	
Hydrogen H <sub>2</sub>	0 ... 2.000 ppm	± 15 % ± 25 ppm
Carbon Monoxide CO	0 ... 2.000 ppm	± 20 % ± 25 ppm
Moisture H <sub>2</sub> O (aw)	0 ... 100 %	± 3 %
Moisture in Mineral Oil	0 ... 100 ppm	± 3 % ± 3 ppm
Moisture in synt. Ester <sup>5)</sup>	0 ... 2.000 ppm	± 3 % of MSC <sup>6)</sup>

<sup>5)</sup>Option <sup>6)</sup>Moisture Saturation Content

## Operation principle

- Diffusion principle with gas-permeable TEFLON membrane
- Micro-electronic gas sensors for H<sub>2</sub> measurement
- Electro-chemical measurement cell for CO measurement
- Thin-film capacitive moisture sensor for H<sub>2</sub>O measurement (relative [%] and absolute [ppm])
- Temperature sensors (oil temperature, gas temperature, back plate temperature)

## Connections

## Analog outputs

4 x Analog DC outputs		Default concentration (Free assignment)
Type	Range	
1 x Current DC	0/4 ... 20 mADC	Hydrogen H <sub>2</sub>
1 x Current DC	0/4 ... 20 mADC	Moisture in Oil H <sub>2</sub> O
1 x Current DC	0/4 ... 20 mADC	
1 x Current DC	0/4 ... 20 mADC	Carbon Monoxide CO

## Digital outputs

12 x Digital outputs		Max. Switching capacity (Free assignment)
Type	Control voltage	
4 x Relay	12 VDC	220 VDC/VAC / 2 A / 60 W
8 x Optocoupler	5 VDC	U <sub>CE</sub> : 24 V rated / 35 V max. U <sub>EC</sub> : 7 V max. I <sub>CE</sub> : 40 mA max.

## Analog inputs

8 x Analog DC inputs		Accuracy of the measuring value	Remarks
Type	Range		
4 x Current DC or 4 x Voltage DC	0/4 ... 20 mA +20% or 0 ... 10 V +20%	≤ 1.0 %	Configurable by jumpers <sup>4)</sup>
4 x Current DC	0/4 ... 20 mA	≤ 0.5 %	

## Communication

- RS 232 - Serial interface with external connector (Proprietary or MODBUS<sup>®</sup> RTU/ASCII protocol)
- RS 485 (proprietary or MODBUS<sup>®</sup> RTU/ASCII protocol)
- ETHERNET 10/100 Mbit/s modem (Option) Copper-wired / RJ45 or fiber-optical / SC duplex connector (Proprietary protocol)
- Analog modem (Option) (Proprietary protocol)
- DNP3 software stack modem (option) RS 485 connection (DNP3 protocol)
- IEC 61850 software stack modem for SCADA connection (option)

## Notes

- 1) 120 V ⇒ 120 V -20% = 96 V<sub>min</sub>      120 V +15% = 138 V<sub>max</sub>  
230 V ⇒ 230 V -20% = 184 V<sub>min</sub>      230 V +15% = 264 V<sub>max</sub>
- 2) Related to temperatures ambient +20°C and oil +55°C
- 3) Accuracy for moisture in oil for mineral oil types
- 4) Default jumper configuration: Current

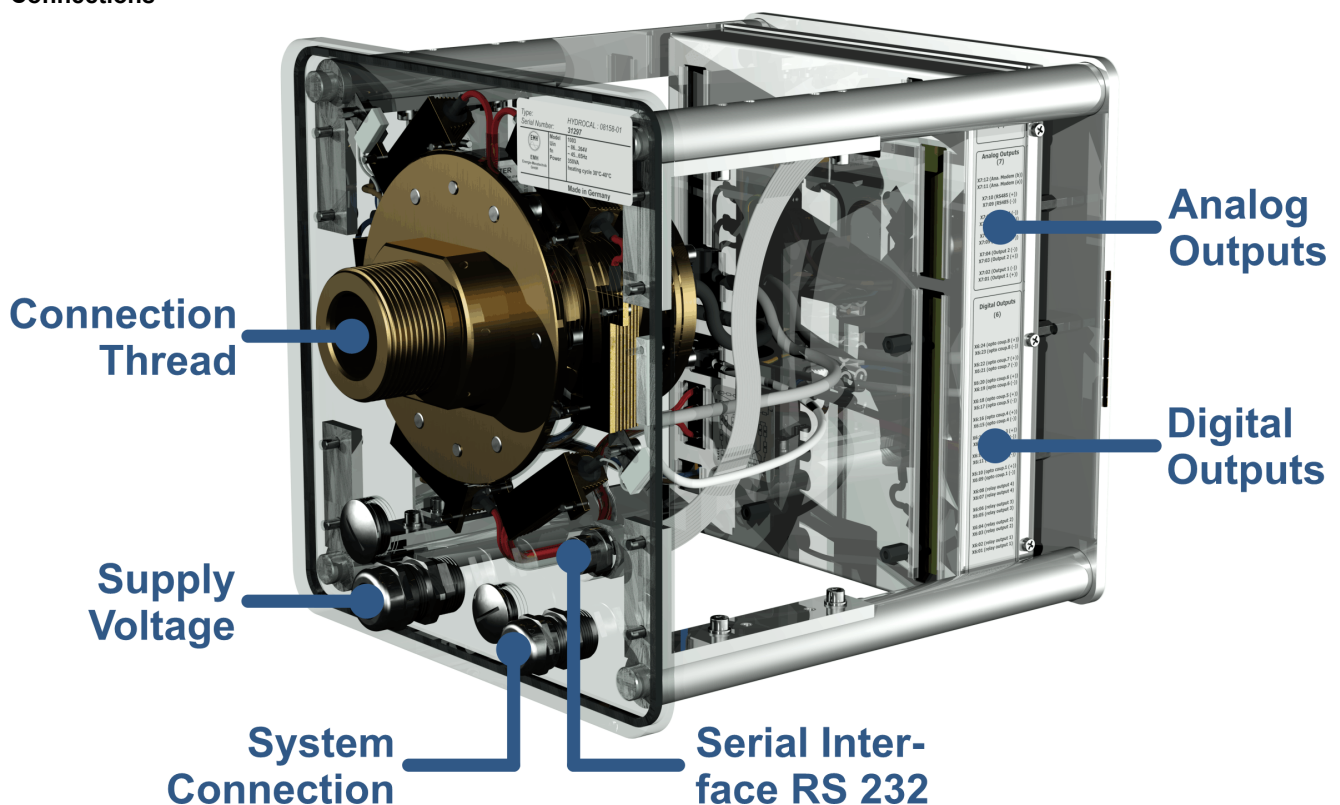

MTE Meter Test Equipment AG

Subject to alterations



Landis + Gyr-Strasse 1 • P.O. Box 7550 • 6302 Zug • Switzerland  
Phone +41-41-508 39 39 • Internet www.mte.ch

11.2024\_R02